

The reproduction, distribution and utilization of this document as well as the communication of its contents to others without express authorization is prohibited. Offenders will be held liable for the payment of damages. All rights reserved in the event of the grant of a patent, utility model or design.

Weitergabe sowie Vervielfältigung dieses Dokuments, Verwertung und Mitteilung seines Inhalts sind verboten, soweit nicht ausdrücklich gestattet. Zuwiderhandlungen verpflichten zu Schadensersatz. Alle Rechte für den Fall der Patent-, Gebrauchsmuster- oder Geschmacksustereintragung vorbehalten.

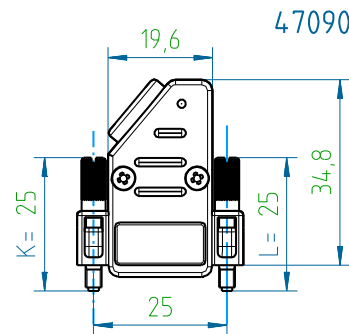

47090M25T001

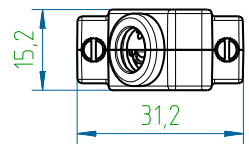
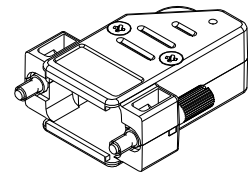

47091M

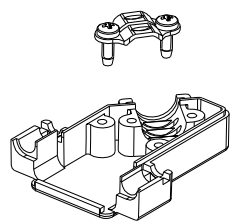
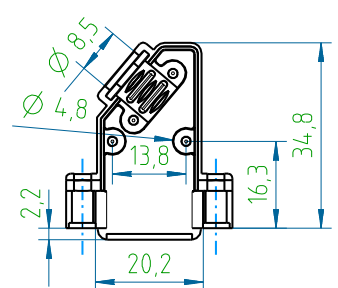

58098T



58094T

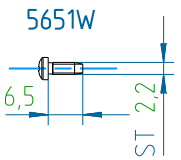

5651W

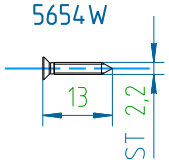

5654W

Verriegelungsschrauben / Locking screws 4-40 UNC:

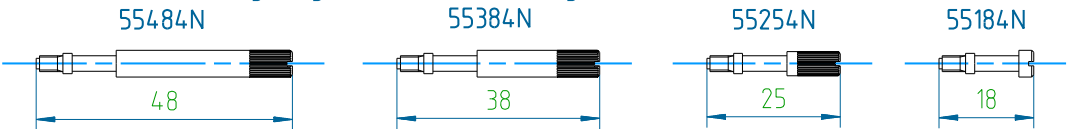

Verriegelungsschrauben / Locking screws M3:



Nummernschlüssel / Numerical code: 47090BxxTVPE / 47090MxxTVPE:
 B - ABS Sicoflex S469 UL94 V-0 E103497, roh / raw
 M - ABS Polylac PA-765 UL94 V-0 E56070, Cu10/Ni5
 xx - Länge der Verriegelungsschrauben / Length of locking screws 4-40 UNC, mm:
 xx=48/38/25/18/00 (00 - ohne Verriegelungsschrauben / without locking screws)
 Beispiel für M3 / Example of M3: 47090MxxM3TVPE
 VPE - Verpackungseinheit 100 Stück / Packaging unit 100 pcs:
 VPE=000 - als Schüttgut / as bulk
 VPE=001 - als Set / as one hood packed as set

Zubehör - Werkstoff, Veredelung / Accessory - material, finishment:
 58098T - Bandstahl / band steel, Cu2/Sn4
 565xW - Einsatzstahl / case hardening steel, A3F DIN ISO 4042
 55xx4N - Automatenstahl / machining steel, Cu2,5/Ni2,5
 (solange Lagerbestand vorhanden / as available on stock: Cu2/Sn5)
 Beispiel mit 58094T anstatt 58098T / Example with 58094T instead of 58098T: 47090MxxTAVPE

47090B00T001	47090M00T001	-	-	7	8
47090B18T001	47090M18T001	18	18	10	11
47090B25T001	47090M25T001	25	25	11	12
47090B38T001	47090M38T001	38	25	13,5	14,5
47090B48T001	47090M48T001	48	25	15	16
Version B	Version M	L, mm (xx)	K, mm	B	M
PVH-Artikel-Nr. / PVH-article no.				Gewicht / weight, g	

55xx4N	55xx4N	2	Verriegelungsschraube / Locking screw
5654W	5654W	2	Blechschaube / Sheet metal screw
5651W	5651W	2	Blechschaube / Sheet metal screw
58098T	58098T	1	Kabelklemme / Cable clamp
47092B	47092M	1	Deckel / Cover
47091B	47091M	1	Gehäuse / Housing

47090BxxTVPE		47090MxxTVPE		Menge / QTY	Artikel-Bezeichnung / Article-name
PVH-Artikel-Nr. / PVH-article no.					
Toleranzen / tolerances:		Projektion / projection:		Maßstab / scale:	
DIN ISO 2768-m				1:1	
		Maßangaben in: dimension units:		Werkstoff / material:	
		mm		Oberfläche cm² / surface cm²:	
				Veredelung / refinement:	
				Gewicht g / weight g:	
				Benennung: name:	
				Kunststoffhaube Gr.1	
				Plastic hood Size 1	
				Zeichnungs-Nr. / drawing no.:	
				47090MXXTVPE-P	
05 neu gezeichnet		19.07.2013	Ast	Blatt / sheet:	
Index		Änderung / modification		1/1	
		Datum		Ersatz für / substitute to:	
		Name		DIN A3	
		Kd.-Zg.:		Vg. 38329	