

The reproduction, distribution and utilization of this document as well as the communication of its contents to others without express authorization is prohibited. Offenders will be held liable for the payment of damages. All rights reserved in the event of the grant of a patent, utility model or design.

17250M38T001

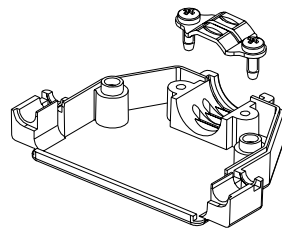

Verriegelungsschrauben / Locking screws 4-40 UNC:

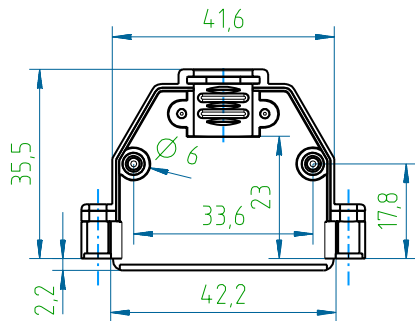
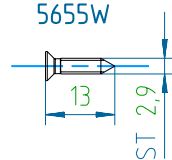
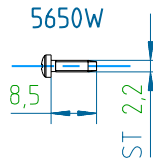
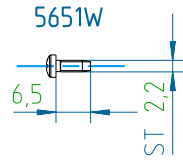
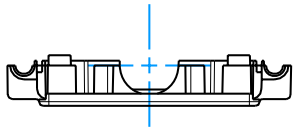
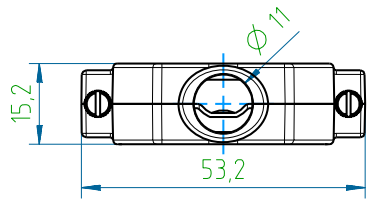
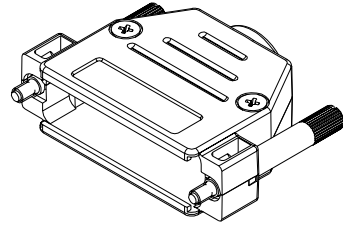
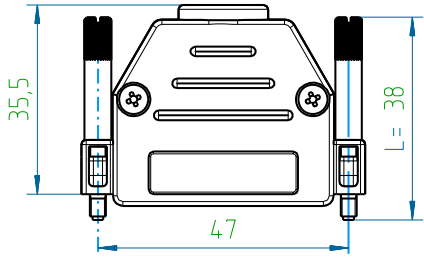
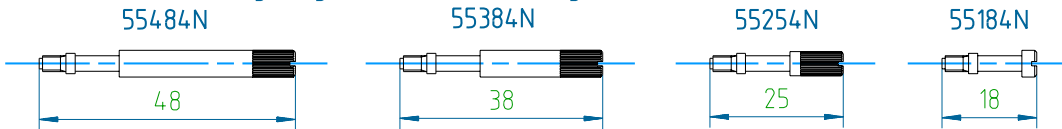

Verriegelungsschrauben / Locking screws M3:



Nummernschlüssel / Numerical code: 17250BxxTVPE / 17250MxxTVPE.

B - ABS Sicoflex S469 UL94 V-0 E103497, roh / raw

M - ABS Polyac PA-765 UL94 V-0 E56070, Cu10/Ni5

xx - Länge der Verriegelungsschrauben / Length of locking screws 4-40 UNC, mm:
 xx=48/38/25/18/00 (00 - ohne Verriegelungsschrauben / without locking screws)

Beispiel für M3 / Example of M3: 17250MxxM3TVPE

VPE - Verpackungseinheit 100 Stück / Packaging unit 100 pcs:

VPE=000 - als Schüttgut / as bulk

VPE=001 - als Set / as one hood packed as set

Zubehör - Werkstoff, Veredelung / Accessory - material, finishment:

58258T - Bandstahl / band steel, Cu2/Sn4

565xW - Einsatzstahl / case hardening steel, A3F DIN ISO 4042

55xx4N - Automatenstahl / machining steel, Cu2,5/Ni2,5

(solange Lagerbestand vorhanden / as available on stock: Cu2/Sn5)

Beispiel mit 58254T anstatt 58258T / Example with 58254T instead of 58258T: 17250MxxTAVPE

5650W - längere Blechschraube für Kabelklemme, bei Bedarf als Zubehör separat bestellen

5650W - longer sheet metal screw for the cable clamp, must be ordered separately as accessory

17250B00T001	17250M00T001	-	10,5	12,5
17250B18T001	17250M18T001	18	13,5	15,5
17250B25T001	17250M25T001	25	14,5	16,5
17250B38T001	17250M38T001	38	19,5	21,5
17250B48T001	17250M48T001	48	22,5	24,5
Version B	Version M	L, mm	B	M
PVH-Artikel-Nr. / PVH-article no.		(xx)	Gewicht / weight, g	

55xx4N	55xx4N	2	Verriegelungsschraube / Locking screw
5655W	5655W	2	Blechschraube / Sheet metal screw
5651W	5651W	2	Blechschraube / Sheet metal screw
58258T	58258T	1	Kabelklemme / Cable clamp
17252B	17252M	1	Deckel / Cover
17251B	17251M	1	Gehäuse / Housing

17250BxxTVPE	17250MxxTVPE	Menge / Qty	Artikel-Bezeichnung / Article-name
PVH-Artikel-Nr. / PVH-article no.			

Toleranzen / tolerances:	Projektion / projection:	Maßstab / scale:	Werkstoff / material: Oberfläche cm² / surface cm²: Veredelung / refinement Gewicht g / weight g
DIN ISO 2768-m		1:1	

Maßangaben in: dimension units:			Benennung: name
mm			
Bearb./drawn:	Datum/date:	Name/name:	Kunststoffhaube Gr.3 Plastic hood Size 3
Gepf./checked:	15.03.2013	Strauch	
			Zeichnungs-Nr. / drawing no. 17250MXXTVPE-P
04 Update	15.03.2013	Ast	

Index	Änderung / modification	Datum	Name	Kd.-Zg.:	Ersatz für / substitute to:	Blatt / sheet 1/1
-------	-------------------------	-------	------	----------	-----------------------------	----------------------