

The reproduction, distribution and utilization of this document as well as the communication of its contents to others without express authorization is prohibited. Offenders will be held liable for the payment of damages. All rights reserved in the event of the grant of a patent, utility model or design.

17150M38T001

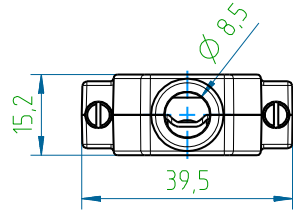
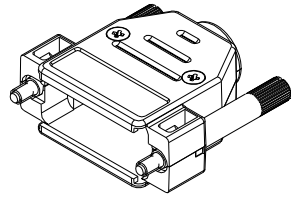
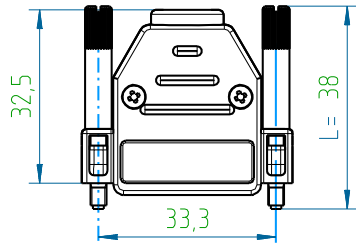

58098T

58094T



5651W

5654W

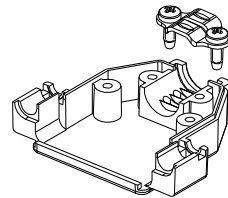
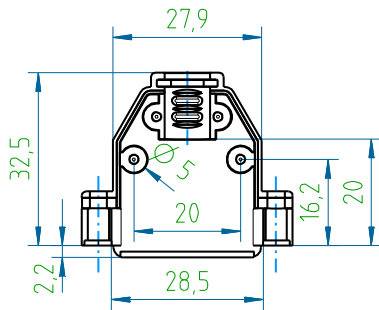
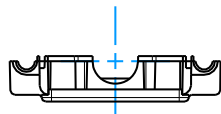
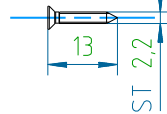
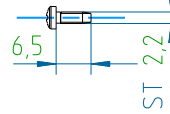

Verriegelungsschrauben / Locking screws 4-40 UNC:

55484N

55384N

55254N

55184N

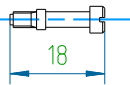
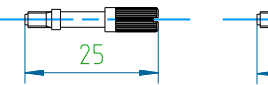
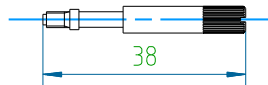
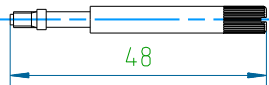

Verriegelungsschrauben / Locking screws M3:

55483N

55383N

55253N

55183N

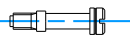
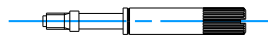
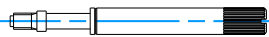

Nummernschlüssel / Numerical code: 17150BxxTVPE / 17150MxxTVPE:

B - ABS Sicoflex S469 UL94 V-0 E103497, roh / raw

M - ABS Polylac PA-765 UL94 V-0 E56070, Cu10/Ni5

xx - Länge der Verriegelungsschrauben / Length of locking screws 4-40 UNC, mm:  
xx=48/38/25/18/00 (00 - ohne Verriegelungsschrauben / without locking screws)

Beispiel für M3 / Example of M3: 17150MxxM3TVPE

VPE - Verpackungseinheit 100 Stück / Packaging unit 100 pcs:

VPE=000 - als Schüttgut / as bulk

VPE=001 - als Set / as one hood packed as set

Zubehör - Werkstoff, Veredelung / Accessory - material, finishment:

58098T - Bandstahl / band steel, Cu2/Sn4

565xW - Einsatzstahl / case hardening steel, A3F DIN ISO 4042

55xx4N - Automatenstahl / machining steel, Cu2,5/Ni2,5

(solange Lagerbestand vorhanden / as available on stock: Cu2/Sn5)

Beispiel mit 58094T anstatt 58098T / Example with 58094T instead of 58098T: 17150MxxTAVPE

Kabeldurchmesser / Cable diameter: Dk=3-8,5 mm

(bei Dk=3-5 mm Kabelklemme wenden / if Dk=3-5 mm turn cable clamp)

17150B00T001	17150M00T001	-	8,0	9,5
17150B18T001	17150M18T001	18	11,0	12,5
17150B25T001	17150M25T001	25	12,0	13,5
17150B38T001	17150M38T001	38	17,0	18,5
17150B48T001	17150M48T001	48	20,0	21,5
Version B	Version M	L, mm (xx)	B	M
PVH-Artikel-Nr. / PVH-article no.			Gewicht / weight, g	

55xx4N	55xx4N	2	Verriegelungsschraube / Locking screw
5654W	5654W	2	Blechschaube / Sheet metal screw
5651W	5651W	2	Blechschaube / Sheet metal screw
58098T	58098T	1	Kabelklemme / Cable clamp
17152B	17152M	1	Deckel / Cover
17151B	17151M	1	Gehäuse / Housing

17150BxxTVPE	17150MxxTVPE	Menge / QTY	Artikel-Bezeichnung / Article-name
PVH-Artikel-Nr. / PVH-article no.			

Toleranzen / tolerances:		Projektion / projection:	Maßstab / scale:	Werkstoff / material: Oberfläche cm² / surface cm²: Veredelung / refinement Gewicht g / weight g
DIN ISO 2768-m			1:1	

Maßangaben in: dimension units:			Benennung: name				
mm							
	Datum / date	Name / name	Kunststoffhaube Gr.2 Plastic hood Size 2				
Bearb./drawn	15.03.2013	Strauch					
Gepr./checked	15.03.2013	Straib					
05 Update	22.01.2014	Asf	Zeichnungs-Nr. / drawing no. 17150MXXTVPE-P				
04 Update	15.03.2013	Asf					
Index	Änderung / modification		Datum	Name	Kd.-Zg.:	Ersatz für / substitute to:	DIN A3

